

McCULLOCH®

PARTNER

ILLUSTRATED PARTS LIST

VIRGINIA MH 542P
VIRGINIA MH 555P
PARTNER HG17 - HG22

SERIAL NUMBER PREFIX 01-02-03

CE

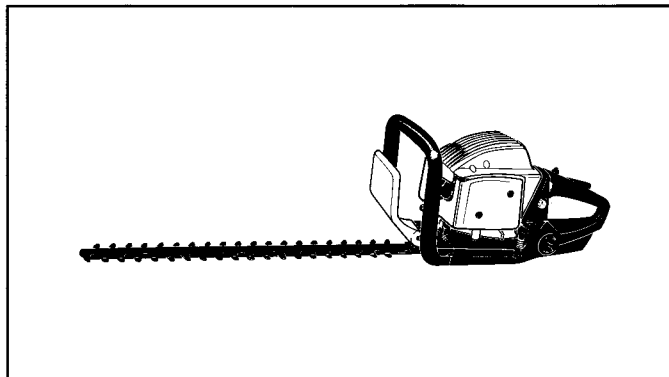

July 2000

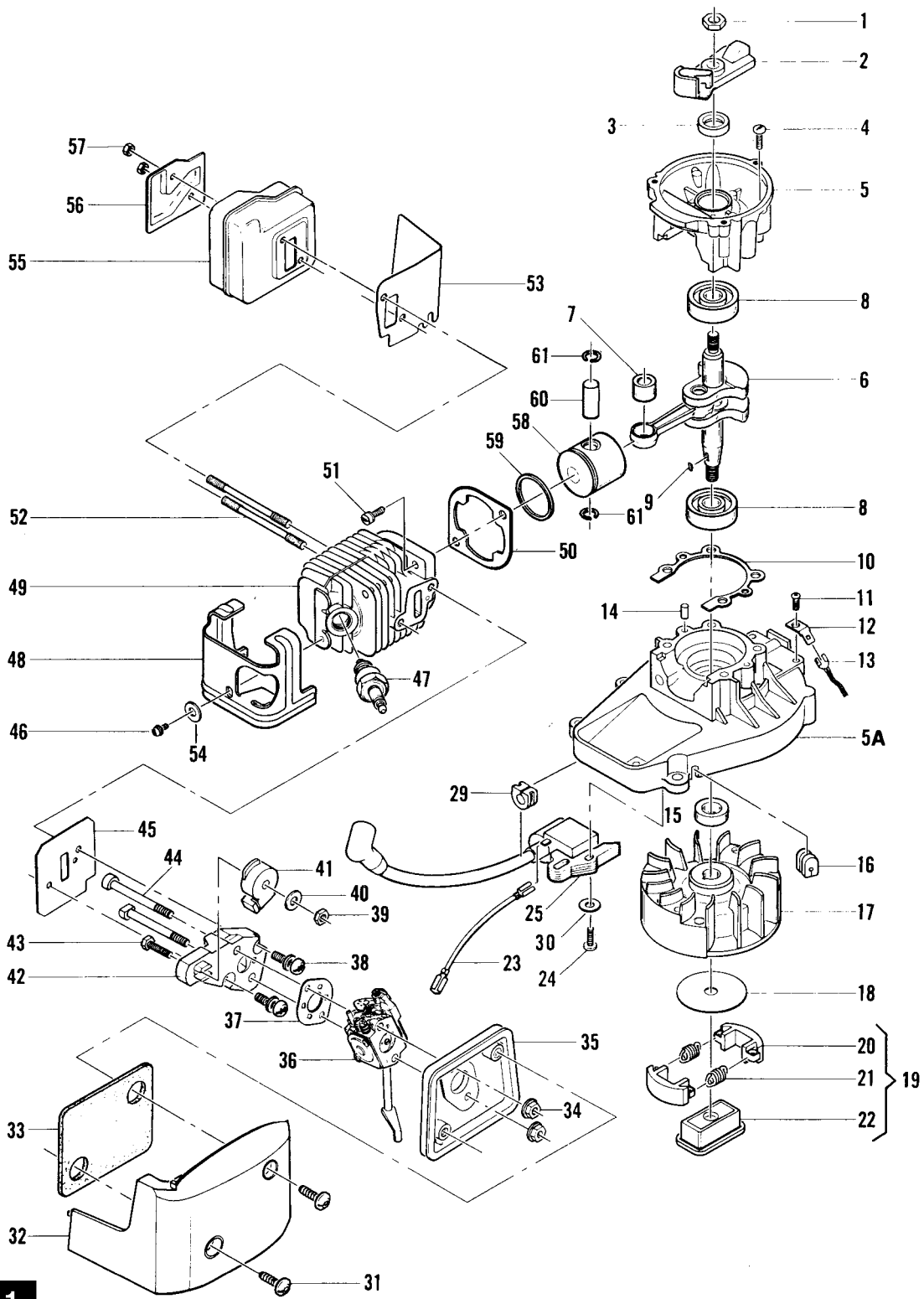

FIGURE 1

1	241624	1	10	241595	1	23	241630	1	39	235642	1	53	241764	1
2	241784	1	11	241976 M4x12	1	24	235806 M5x20	2	40	235163	1	54	235248	1
C 3	241596	1	12	228139	1	C 25	241749	1	41	241644	1	C 55	301833-01	1
4	235804 M5x30	4	13	241867	1	29	236322	1	C 42	241590	1	56	322231	1
5	241748	1	14	241597	2	30	235248	2	43	240131 M5x20	1	57	235642	2
5 A	241720	1	C 15	241596	1	31	218644	2	44	111057	2	C 58	301317-01 Prefix 01-02	1
6	241627 Prefix 01	1	16	241607	1	32	241651 yellow/giallo/gaune/gelb	1	B 45	241643	1	B 59	● 241593	2
	241806 Prefix 02	1	17	222372 Prefix 01	1		241860 gold/oro/or/gold	1	46	236381 M5x10	1	60	● 241591	1
	242003 Prefix 03	1		241796 Prefix 02-03	1	B 33	241652	1	A 47	92879	1	61	● 241592	2
C 7	● 323930 Prefix 01-02	1	18	241604	1	34	111058	2	48	224165	1	C 58	248177 Prefix 03	1
C	● 235742 Prefix 03	1	B 19	241792	1	35	241647	1	C 49	302000	1	B 59	● 240002	1
8	241594	2	20	● 241790	2	C 36	FIGURE 3		B 50	241598	1	60	● 241735	1
C 9	102164 Prefix 01	1	A 21	● 241794	2	A 37	241600	1	51	236933 M6x18	2	61	● 235008	2
C	227631 Prefix 02-03	1	22	● 241789	1	38	235806 M5x20	2	52	241804	2			

A = high moving - alta rotazione - haute demande - große Nachfrage B = medium moving - media rotazione - moyenne demande - mittelmäßige Nachfrage C = slow moving - bassa rotazione - basse demande - wenige Nachfrage

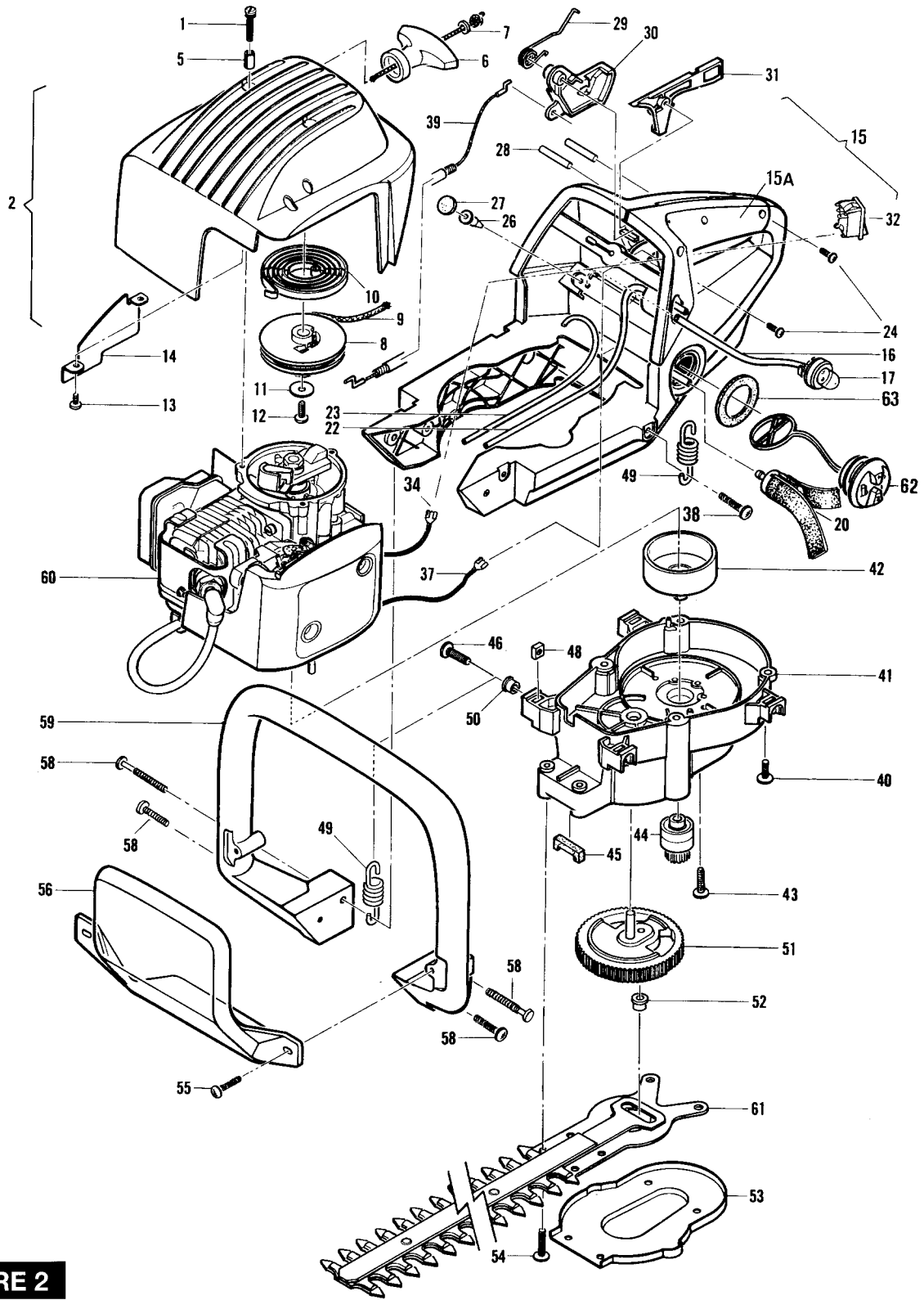

FIGURE 2

1	241963 M4x22	3	14	● 241758	1	29	● 241637	1	44	● 225007-01	1	58	219883	4
2	241648 yellow/gold/br/gold	1	C 15	241866	1	C 30	● 241635	1	45	● 241633	1	59	241868	1
	241858 gold/oro/or/gold	1	15 A	● 241846	1	C 31	● 241636	1	46	● 217936	4	60	FIGURE 1	
5	● 241617	3	B 16	● 241777	1	C 32	● 228277	1	48	● 218005	4	C 61	241655 MH 542PHG17	1
6	● 241778	1	C 17	● 224242-01	1	34	● 241867	1	C 49	● 241634	4	C	241656 MH 555PHG22	1
7	● 235612	1	A 20	● 240452	1	37	241630	1	50	● 241765	4	B 62	241234	1
B 8	● 241620	1	B 22	● 241776	1	38	111117	2	C 51	241653	1	C 63	● 235510	1
A 9	● 241746	1	B 23	● 241775	1	C 39	241642	1	B 52	241754	1			
B 10	● 241619	1	24	● 240862	3	40	111119	4	53	241761	1			
11	● 241703	1	C 26	● 322199	1	41	241631	1	54	111117	6			
12	● 300294	1	C 27	● 241717	1	C 42	● 225006-02	1	55	111117	2			
13	● 111069	2	28	● 241762	2	43	● 218644	2	56	241654	1			

A = high moving - alta rotazione - haute demande - große Nachfrage

B = medium moving - media rotazione - moyenne demande - mittelmäßige Nachfrage

C = slow moving - bassa rotazione - basse demande - wenige Nachfrage

ZAMA M32-B

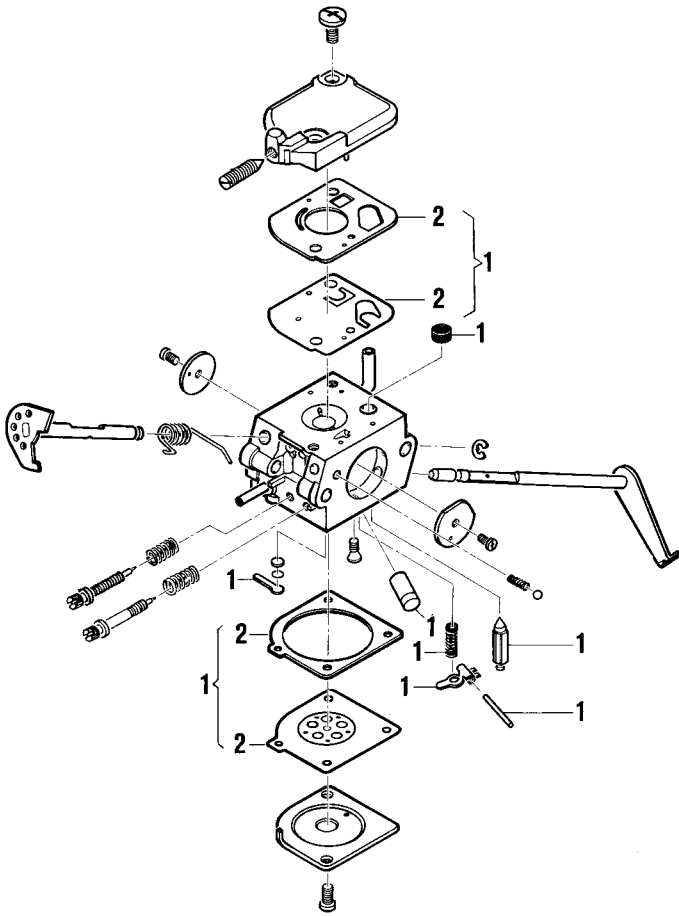

C	-	241646	carbur.
B	1	• 300465	1
A	2	•• 300473	1

FIGURE 3

A = high moving - alta rotazione - haute demande - große Nachfrage
 B = medium moving - media rotazione - moyenne demande - mittelmäßige Nachfrage
 C = slow moving - bassa rotazione - basse demande - wenige Nachfrage